

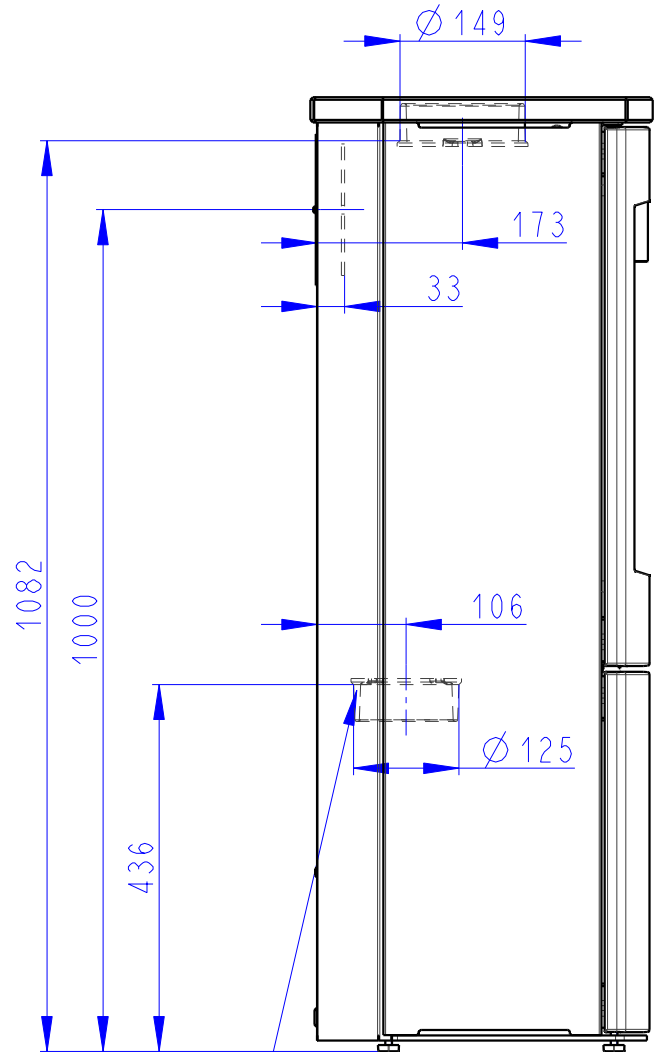

NEMEA 3020

PLATEAU EN STÉATITE
 TOPPLATTE SPECKSTEIN
 TOP PLATE SOAPSTONE

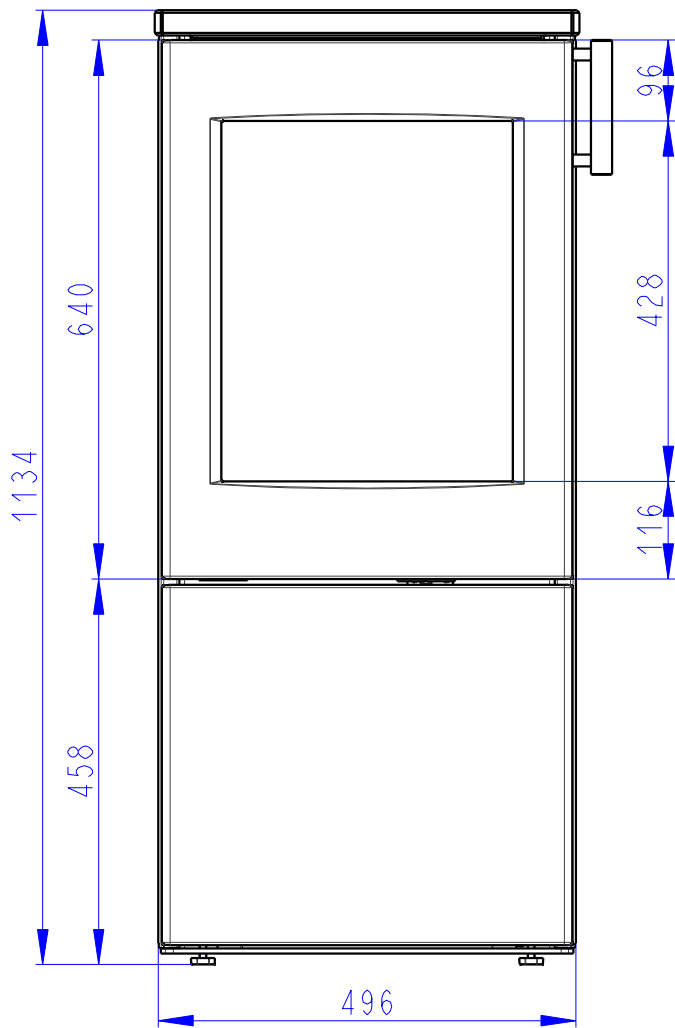

Arrivée d'air central
 Zentralluftzufuhr
 Central air inlet

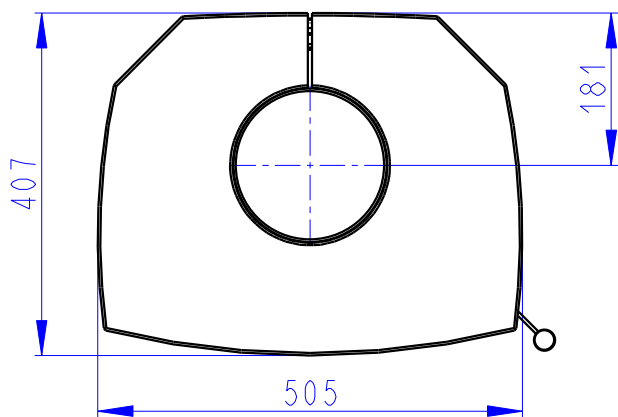

Air primaire
 Air secondaire
 Air tertiaire
 Primärluft
 Sekundärluft
 Tertiärluft
 Primary air
 Secondary air
 Tertiary air

